

1.2V Input / Output Rail To Rail CMOS Op Amp

■ GENERAL DESCRIPTION

The XC221A series is an input / output rail to rail CMOS Op Amp.

With rail to rail functions, operation is guaranteed from power supplies as low as 1.2V. Moreover, since the XC221A series comes in an ultra small SOT-25 package, the series is particularly suited for use with various types of portable phones.

Bandwidths of 550kHz and slew rates of 0.5V can be achieved even with power consumption as low as 100 μ A.

Even with large capacitance levels of $CL = 200\text{pF}$ (unity gain connection), the XC221A series will not be susceptible to oscillation.

■ APPLICATIONS

- Palmtop computers, PDAs
- Cellular and portable phones
- Portable audio systems
- Various battery powered systems

■ FEATURES

- Operating Voltage Range:** 1.2 ~ 10V (single cell)
: $\pm 0.6 \sim 5\text{V}$ (+ve/-ve supply)
- Output Signal** : 0.1~2.9V (3V single cell, $RL=2\text{k}\Omega$)
- Gain Bandwidth** : 550kHz (15 μ A: 210kHz)
- Slew Rate** : 0.5V/ μ s
- High Capacitance Load** : $CL=200\text{pF}$
- Low Supply Current** : 100 μ A, 15 μ A
- Input / Output Rail To Rail Operation**
- Ultra Small Package** : SOT-25

■ PIN CONFIGURATION

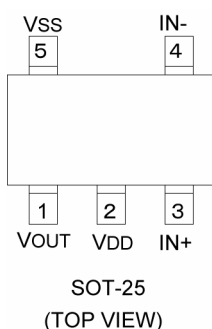

■ PIN ASSIGNMENT

PIN NUMBER	SYMBOL	FUNCTION
1	VOUT	Output Pin
2	VDD	Positive Power Supply Pin
3	IN+	Positive Input
4	IN-	Negative Input
5	VSS	Negative Power Supply Pin

■ PRODUCT CLASSIFICATION

● Ordering Information

XC221A①②③④⑤⑥

DESIGNATOR	DESCRIPTION	SYMBOL	DESCRIPTION
①	The Number of Channels	1	: One channel
②	Supply Current	1	: 15 μ A
		2	: 100 μ A
③	Internal Standard Number	0	: Fixed
④	Load Capacitance	0	: 200pF
⑤	Package	M	: SOT-25 (SOT-23-5)
⑥	Device Orientation	R	: Embossed tape, standard feed
		L	: Embossed tape, reverse feed

■ ABSOLUTE MAXIMUM RATINGS

Ta = 25°C, Vss = 0V

PARAMETER	SYMBOL	RATINGS	UNITS
VDD Pin Voltage	VDD	-0.3 ~ 12.0	V
OUT Pin Voltage	VOUT	-0.3 ~ 12.0	V
IN Pin Voltage	VIN+	-0.3~VDD+0.3	V
IN/ Pin Voltage	VIN-	-0.3~VDD+0.3	V
OUT Pin Current	IOUT	\pm 100	mA
Power Dissipation	Pd	150	mW
Operating Temperature Range	Topr	-30 ~ +80	°C
Storage Temperature Range	Tstg	-40 ~ +125	°C

RAIL-TO-RAIL is a trademark of Motorola.

■ ELECTRICAL CHARACTERISTICS

XC221A1100		I _{DD} = 15 μA		Ta = 25°C		
PARAMETER	SYMBOL	CONDITIONS	MIN.	TYP.	MAX.	UNITS
Supply Voltage	V _{DD}		1.2	-	10.0	V
Supply Current	I _{DD}	V _{DD} = 3V	10	15	23	μA
		V _{DD} = 1.2V	2.5	8	23	μA
Input Offset Voltage	V _{OF}		-	-	20.0	mV
Input Offset Current	I _{OF}		-	1	-	pA
Input Bias Current	I _B		-	1	-	pA
Input Resistance	R _{IN}		-	1	-	TΩ
Large Signal Voltage Gain	AV _D		75	110	-	dB
Common Mode Rejection Ratio	CMRR	0 ≤ V _{CM} ≤ 3.0V	60	75	-	dB
Power Supply Rejection Ratio	PSRR+	V _{DD} = 3 to 10V, V _{SS} = 0V, V _{OUT} = 1.5V	60	75	-	dB
	PSRR-	V _{SS} = -3 to -10V, V _{DD} = 0V, V _{OUT} = -1.5V	60	75	-	dB
Output Voltage Range	V _{OUT}	R _L = ∞	0.05	-	V _{DD} -0.05	V
		V _{DD} = 1.2V, R _L = 47kΩ (to V _{DD} /2)	0.10	-	1.10	V
		V _{DD} = 3V, R _L = 2kΩ (to V _{DD} /2)	0.10	-	2.90	V
		V _{DD} = 5V, R _L = 2kΩ (to V _{DD} /2)	0.10	-	4.90	V
		V _{DD} = 10V, R _L = 2kΩ (to V _{DD} /2)	0.10	-	9.80	V
Gain Bandwidth	FT	V _{DD} = 3V	-	210	-	kHz
Slew Rate	SR	V _{DD} = 3V	-	0.07	-	V/μsec

Test Conditions : Unless otherwise stated, V_{DD} = 3.0V, V_{SS} = 0V, V_{CM} = V_{OUT} = V_{DD} / 2, R_L = 1MΩ (to V_{SS}), C_L = 10pF (to V_{SS})

XC221A1200		I _{DD} = 100 μA		Ta = 25°C		
PARAMETER	SYMBOL	CONDITIONS	MIN.	TYP.	MAX.	UNITS
Supply Voltage	V _{DD}		1.2	-	10.0	V
Supply Current	I _{DD}	V _{DD} = 3V	67	100	150	μA
		V _{DD} = 1.2V	16.75	50.00	150.00	μA
Input Offset Voltage	V _{OF}		-	-	20.0	mV
Input Offset Current	I _{OF}		-	1	-	pA
Input Bias Current	I _B		-	1	-	pA
Input Resistance	R _{IN}		-	1	-	TΩ
Large Signal Voltage Gain	AV _D		75	110	-	dB
Common Mode Rejection Ratio	CMRR	0 ≤ V _{CM} ≤ 3.0V	60	75	-	dB
Power Supply Rejection Ratio	PSRR+	V _{DD} = 3 to 10V, V _{SS} = 0V, V _{OUT} = 1.5V	60	75	-	dB
	PSRR-	V _{SS} = -3 to -10V, V _{DD} = 0V, V _{OUT} = -1.5V	60	75	-	dB
Output Voltage Range	V _{OUT}	R _L = ∞	0.05	-	V _{DD} -0.05	V
		V _{DD} = 1.2V, R _L = 47kΩ (to V _{DD} /2)	0.10	-	1.10	V
		V _{DD} = 3V, R _L = 2kΩ (to V _{DD} /2)	0.10	-	2.90	V
		V _{DD} = 5V, R _L = 2kΩ (to V _{DD} /2)	0.10	-	4.90	V
		V _{DD} = 10V, R _L = 2kΩ (to V _{DD} /2)	0.10	-	9.80	V
Gain Bandwidth	FT	V _{DD} = 3V	-	550	-	kHz
Slew Rate	SR	V _{DD} = 3V	-	0.50	-	V/μsec

Test Conditions : Unless otherwise stated, V_{DD} = 3.0V, V_{SS} = 0V, V_{CM} = V_{OUT} = V_{DD} / 2, R_L = 1MΩ (to V_{SS}), C_L = 10pF (to V_{SS})

TYPICAL PERFORMANCE CHARACTERISTICS

●XC221A1100 <15 μ A>

(1) Voltage Gain vs. Phase Margin

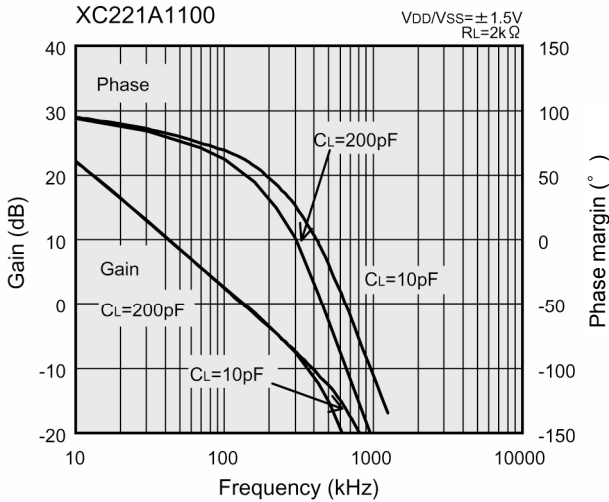

(2) Sink Current vs. Output Voltage

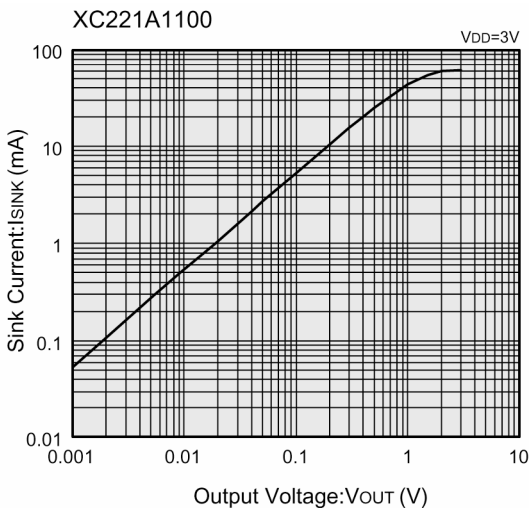

(3) Source Current vs. Output Voltage

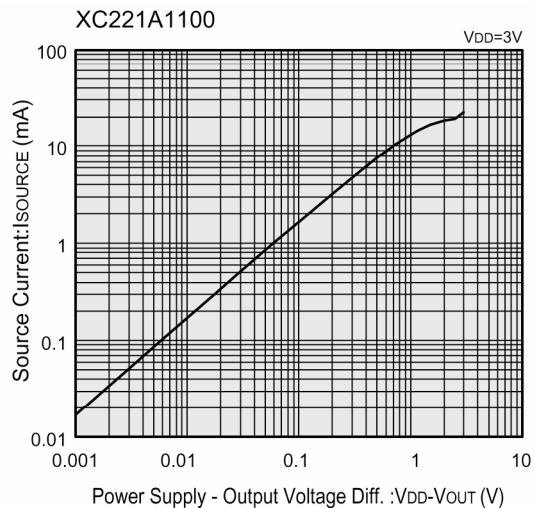

(4) Supply Current vs. Power Supply Voltage

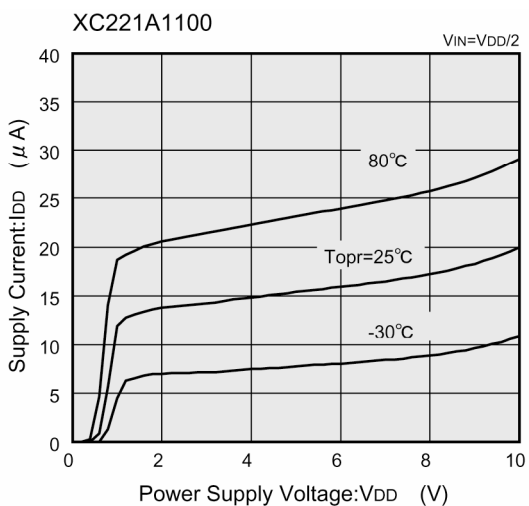

(5) Supply Current vs. Ambient Temperature

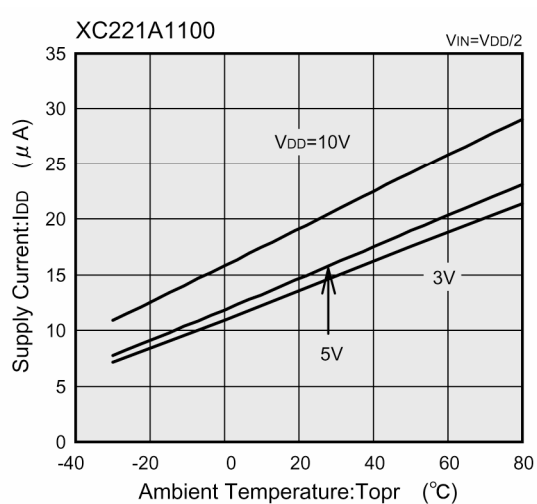

■ TYPICAL PERFORMANCE CHARACTERISTICS (Continued)

● XC221A1100 <15 μ A> (Continued)

(6) Power Supply Rejection Ratio vs. Frequency

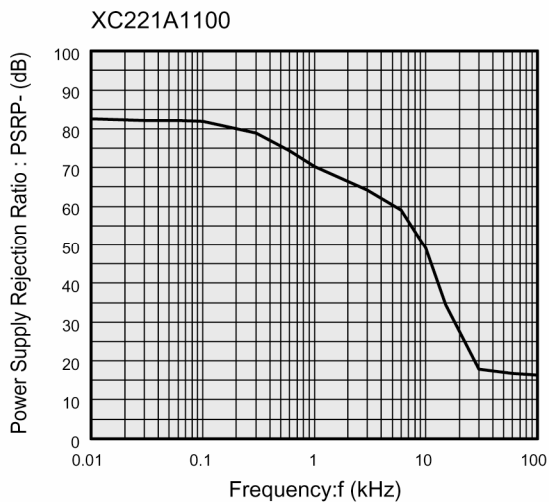
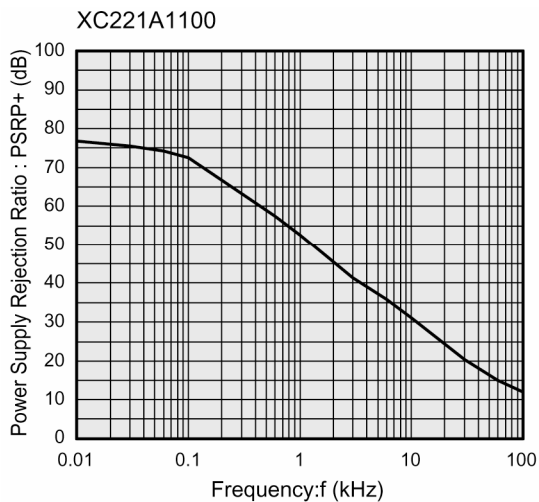

(7) Large Signal Input / Output Response

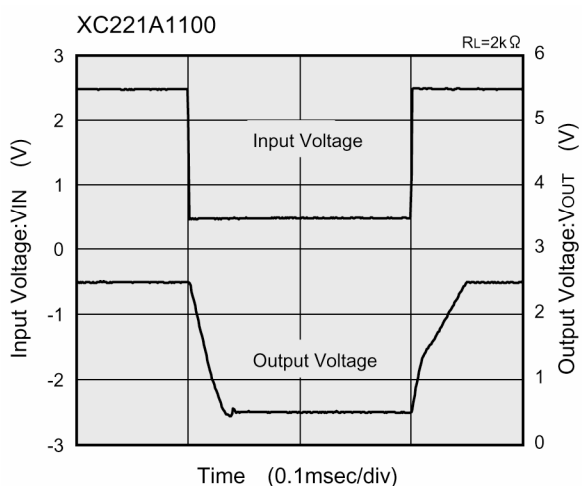

(8) Small Signal Input / Output Response

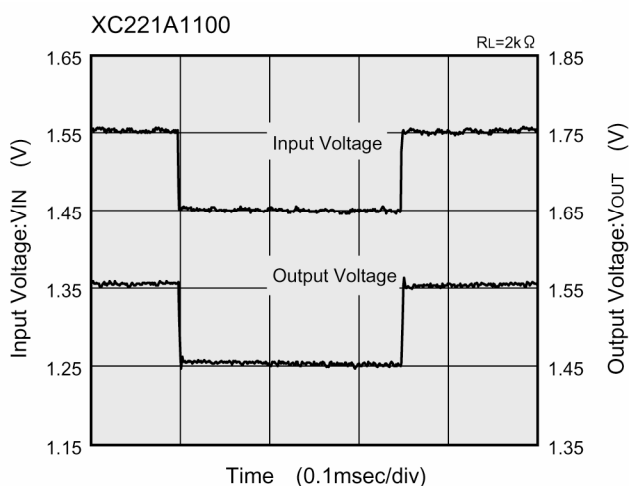

TYPICAL PERFORMANCE CHARACTERISTICS (Continued)

●XC221A1200 <100 μA>

(1) Voltage Gain vs. Phase Margin

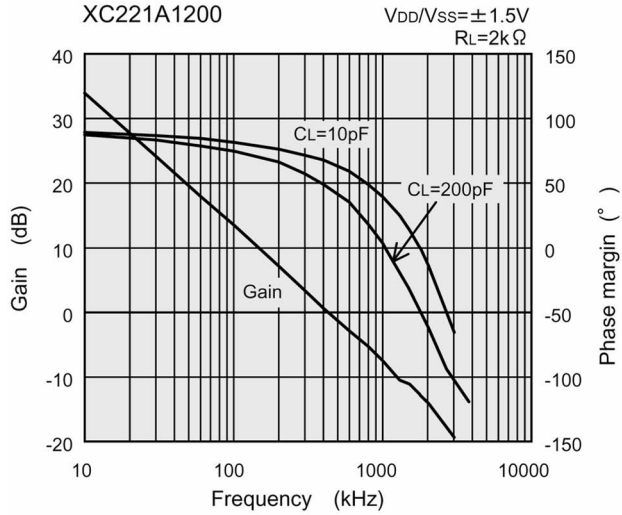

(2) Sink Current vs. Output Voltage

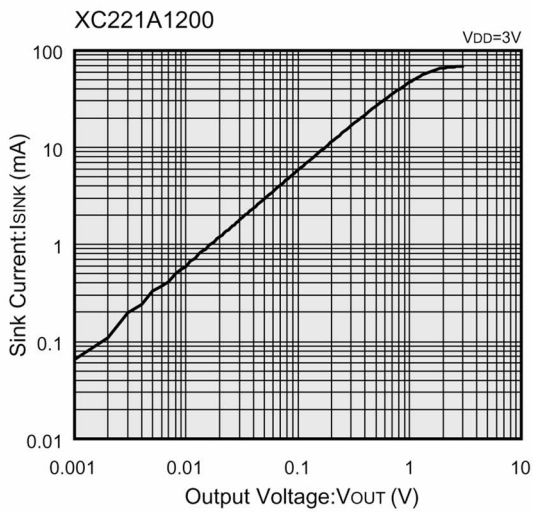

(3) Source Current vs. Output Voltage

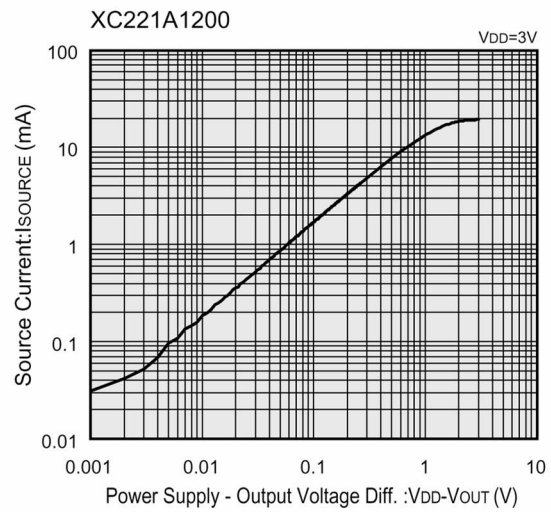

(4) Supply Current vs. Power Supply Voltage

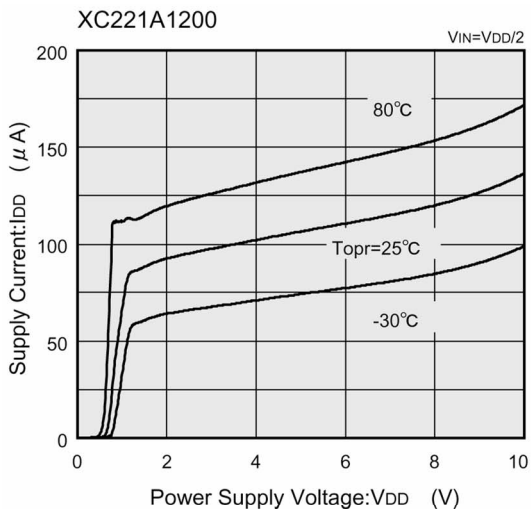

(5) Supply Current vs. Ambient Temperature

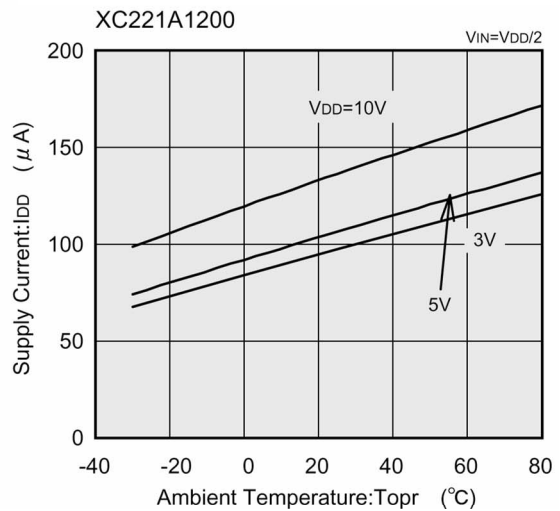

TYPICAL PERFORMANCE CHARACTERISTICS (Continued)

●XC221A1200 <100 μ A> (Continued)

(6) Power Supply Rejection Ratio vs. Frequency

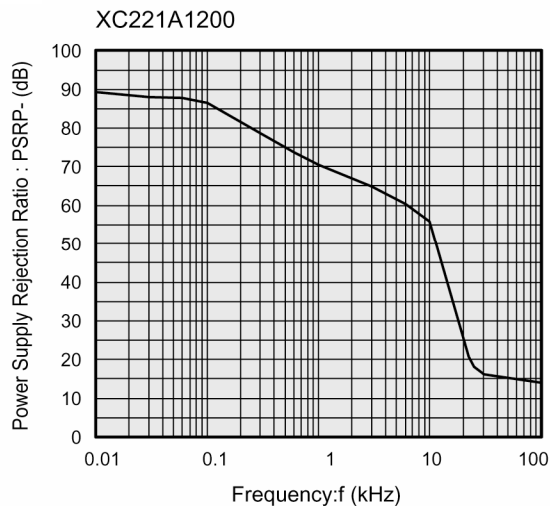
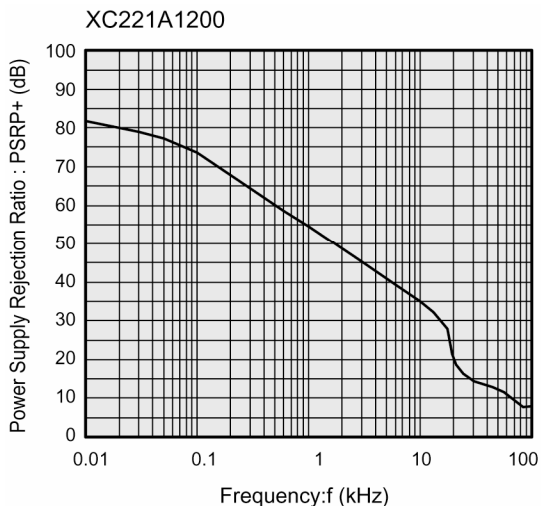

(7) Large Signal Input / Output Response

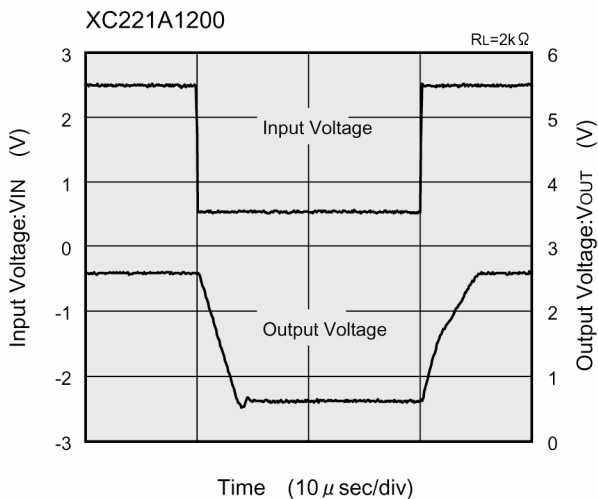

(8) Small Signal Input / Output Response

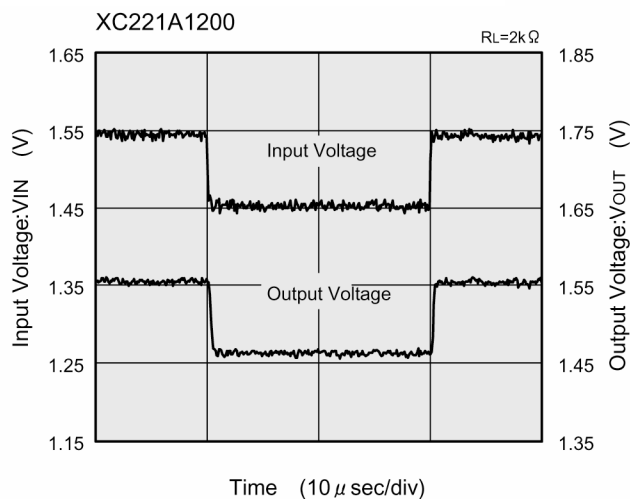

PACKAGING INFORMATION

SOT-25

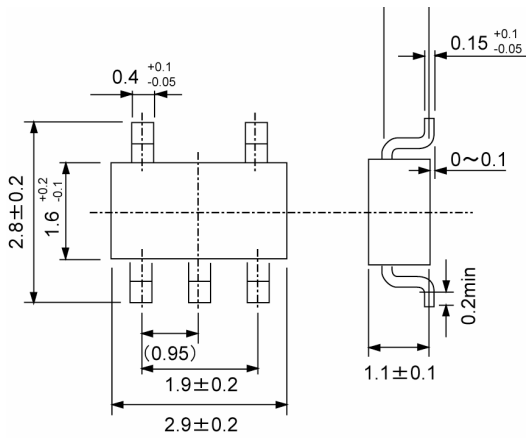

MARKING RULE

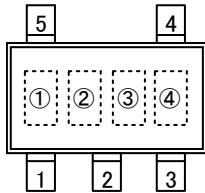

SOT-25
(TOP VIEW)

① Represents product series and supply current

MARK	PRODUCT SERIES	SUPPLY CURRENT
1	XC221A11	15 μ A
2	XC221A12	100 μ A

② Based on internal standards

③ Represents load capacitance

MARK	LOAD CAPACITANCE
0	200pF

④ Represents the production lot number

0 to 9, A to Z repeated (G, I, J, O, Q, W excepted)

1. The products and product specifications contained herein are subject to change without notice to improve performance characteristics. Consult us, or our representatives before use, to confirm that the information in this catalog is up to date.
2. We assume no responsibility for any infringement of patents, patent rights, or other rights arising from the use of any information and circuitry in this catalog.
3. Please ensure suitable shipping controls (including fail-safe designs and aging protection) are in force for equipment employing products listed in this catalog.
4. The products in this catalog are not developed, designed, or approved for use with such equipment whose failure of malfunction can be reasonably expected to directly endanger the life of, or cause significant injury to, the user.
(e.g. Atomic energy; aerospace; transport; combustion and associated safety equipment thereof.)
5. Please use the products listed in this catalog within the specified ranges.
Should you wish to use the products under conditions exceeding the specifications, please consult us or our representatives.
6. We assume no responsibility for damage or loss due to abnormal use.
7. All rights reserved. No part of this catalog may be copied or reproduced without the prior permission of Torex Semiconductor Ltd.

TOREX SEMICONDUCTOR LTD.